

# Console Legs





# Loft



491 WORTMAN AVENUE  
SPRING CREEK, NY 11208  
T 718.257.2800  
F 718.257.2144  
INFO@WATERMARK-DESIGNS.COM  
WWW.WATERMARK-DESIGNS.COM

**WATERMARK**  
DESIGNS

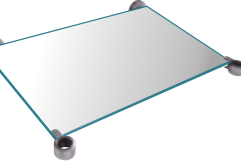
# Console Legs

	MODEL NO.	DESCRIPTION	NOTES
<b>LOFT - Stone/ marble / glass / wood top</b>			
	CON24-LFTST	24"	
	CON30-LFTST	30"	
	CON36-LFTST	36"	
	CON60-LFTST	60" double	
	CON72-LFTST	72" double	
<b>China top</b>			
	CON32-LFTCH	32" (will work with Kohler Kathryn Console table K-3020)	
<b>Accessories</b>			
	CON24-LFT-0.8GLS	tempered glass shelf	for 24" console
	CON30-LFT-0.8GLS		for 30" console
	CON36-LFT-0.8GLS		for 36" console
	CON60-LFT-0.8GLS	tempered glass shelf -for double consoles	for 60" double console
	CON72-LFT-0.8GLS		for 72" double console
	CON24-LFT-0.8LW	solid wood shelf -light	for 24" console
	CON30-LFT-0.8LW		for 30" console
	CON36-LFT-0.8LW		for 36" console
	CON60-LFT-0.8LW	solid wood shelf -light -for double consoles	for 60" console
	CON72-LFT-0.8LW		for 72" console





	MODEL NO.	DESCRIPTION	NOTES
	CON24-LFT-0.8DW	solid wood shelf -dark	for 24" console
	CON30-LFT-0.8DW		for 30" console
	CON36-LFT-0.8DW		for 36" console
	CON60-LFT-0.8DW	solid wood shelf -dark -for double consoles	for 60" double console
	CON72-LFT-0.8DW		for 72" double console
	CON-LFT-0.1	16" towel bar	
	CON-LFT-0.5	hook	
	CON-LFT-0.4	paper holder	
	CON-LFT-EXT1	extension for single consoles	
	CON-LFT-EXT2	extension for double consoles	

491 WORTMAN AVENUE  
 SPRING CREEK, NY 11208  
 T 718.257.2800  
 F 718.257.2144  
 INFO@WATERMARK-DESIGNS.COM  
 WWW.WATERMARK-DESIGNS.COM

# Console Legs

# Transitional



	MODEL NO.	DESCRIPTION	NOTES
<b>Transitional - Stone/ marble / glass / wood top</b>			
	CON24-TRNST	24"	
	CON30-TRNST	30"	
	CON36-TRNST	36"	
	CON60-TRNST	60" double	
	CON72-TRNST	72" double	
<b>China top</b>			
	CON30-TRNCH	30" (will work with Kohler Memoirs Console table K-2269)	
<b>Accessories</b>			
	CON24-TRN-0.8GLS	tempered glass shelf	for 24" console
	CON30-TRN-0.8GLS		for 30" console
	CON36-TRN-0.8GLS		for 36" console
	CON60-TRN-0.8GLS	tempered glass shelf -for double consoles	for 60" double console
	CON72-TRN-0.8GLS		for 72" double console

491 WORTMAN AVENUE  
 SPRING CREEK, NY 11208  
 T 718.257.2800  
 F 718.257.2144  
 INFO@WATERMARK-DESIGNS.COM  
 WWW.WATERMARK-DESIGNS.COM

# Console Legs

	MODEL NO.	DESCRIPTION	NOTES
	CON24-TRN-0.8LW	solid wood shelf -light	for 24" console
	CON30-TRN-0.8LW		for 30" console
	CON36-TRN-0.8LW		for 36" console
	CON60-TRN-0.8LW	solid wood shelf -light -for double consoles	for 60" double console
	CON72-TRN-0.8LW		for 72" double console
	CON24-TRN-0.8DW	solid wood shelf -dark	for 24" console
	CON30-TRN-0.8DW		for 30" console
	CON36-TRN-0.8DW		for 36" console
	CON60-TRN-0.8DW	solid wood shelf -dark -for double consoles	for 60" double console
	CON72-TRN-0.8DW		for 72" double console
	CON-TRN-0.1	16" towel bar	
	CON-TRN-0.5	hook	
	CON-TRN-0.4	paper holder	
	CON-TRN-EXT1	extension for single consoles	
	CON-TRN-EXT2	extension for double consoles	

# Traditional



# Console Legs

SPECIFY TOP BASE AND FOOT BASE WHEN ORDERING

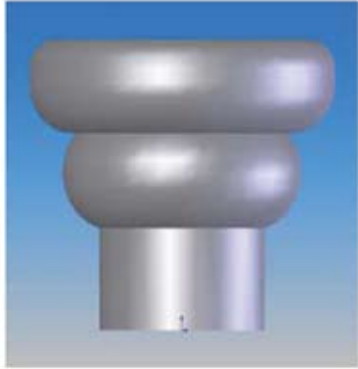

**TB1**



**TB2**

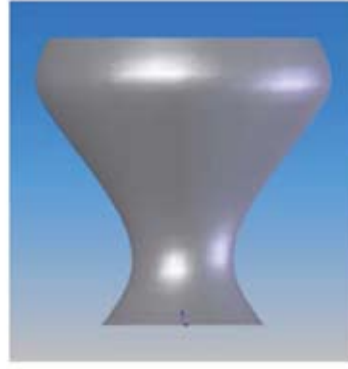

**TB3**



**STRAIGHT (S)**



**FB1**







**FB2**







**FB3**



**TAPERED (T)**

	MODEL NO.	DESCRIPTION	NOTES
<b>Traditional - Stone/ marble / glass /wood top</b>			
	CON24-TRDST-S	24" straight leg	
	CON24-TRDST-T	24" tapered leg	
	CON30-TRDST-S	30" straight leg	
	CON30-TRDST-T	30" tapered leg	
	CON36-TRDST-S	36" straight leg	
	CON36-TRDST-T	36" tapered leg	
	CON60-TRDST-S	60" double straight leg	
	CON60-TRDST-T	60" double tapered leg	
	CON72-TRDST-S	72" double straight leg	
	CON72-TRDST-T	72" double tapered leg	
<b>China Top</b>			
	CON42-TRDCH-S	42" straight leg ( will work with Kohler Caxton console table K-3025)	
	CON42-TRDCH-T	42" tapered leg ( will work with Kohler Caxton console table K-3025)	
<b>Accessories</b>			
	CON24-TRD-0.8GLS	tempered glass shelf	for 24" console
	CON30-TRD-0.8GLS		for 30" console
	CON36-TRD-0.8GLS		for 36" console
	CON60-TRD-0.8GLS	tempered glass shelf -for double consoles	for 60" console
	CON72-TRD-0.8GLS		for 72" console
	CON24-TRD-0.8LW	solid wood shelf -light	for 24" console
	CON30-TRD-0.8LW		for 30" console
	CON36-TRD-0.8LW		for 36" console
	CON60-TRD-0.8LW	solid wood shelf -light -for double consoles	for 60" double console
	CON72-TRD-0.8LW		for 72" double console

# Console Legs

	MODEL NO.	DESCRIPTION	NOTES
	CON24-TRD-0.8DW	solid wood shelf -dark	for 24" console
	CON30-TRD-0.8DW		for 36" console
	CON36-TRD-0.8DW		for 36" console
	CON60-TRD-0.8DW	solid wood shelf -dark -for double consoles	for 60" double console
	CON72-TRD-0.8DW		for 72 " double console
	CON-TRD-0.1	16" towel bar	
	CON-TRD-0.5	hook	
	CON-TRD-0.4	paper holder	
	CON-TRD-EXT1	extension for single consoles (will not work for tapered legs)	
	CON-TRD-EXT2	extension for double consoles (will not work for tapered legs)	